

Service
Service
Service



Service Manual



CONTENTS

Technical Specification.....	1-1..1-7
Version Variation.....	2-1
Safety Instruction.....	2-2
Block diagram.....	3-1
Wiring diagram	3-2
Circuit Diagram	
Main + KEY board.....	4-1
Main board.....	4-2
Layout diagram	
MAIN BOARD Layout.....	5-1 5-2
KEY Layout.....	5-3
Explode Drawing.....	6-1

©Copyright 2011 Philips Consumer Electronics B.V. Eindhoven, The Netherlands
All rights reserved. No part of this publication may be reproduced, stored in a retrieval system or transmitted, in any form or by any means, electronic, mechanical, photocopying, or otherwise without the prior permission of Philips.



TECHNICAL SPECIFICATION

General description:							
LIFETIME : 5 years (acc. to UAN-D1611)							
PERFORMANCE CLASSES :							
	Tuner	SUPPLY, aMPLifier	SPEAKER BOXES	R E C	CLOCK	CD	TELEPHONE
I	x	x					
II						x	
SAFETY REQUIREMENTS:							
EN 60065 (IEC 65) CE							
RADIATION, IMMUNITY REQUIREMENTS: (EMC)							
EN55013, EN55020, (Version 55 approbation CB only)							
CLIMATIC REQUIREMENTS: (acc. to UAN-D1590)							
All climates: -10 °C till +50 °C (Functional); Set has to be pre-conditioned for 2 hour, except CD function							
For all measurements: 25 °C							
POWER SUPPLY:							
MAINS (AC) operation				DC (int. or ext.) operation / Backup			
Voltage selection:		See table below		Battery type: R14, UM2, C-cell x 6; nom.: 9V			
				minimum operating voltage : 6.3V for CD			
				5.4V for TU			
Selection:		See table below		Lifetime: CD ≥ 10 hours, TU ≥ 20 hours,			
				(R14 金霸王 alkaline batteries)			
Frequency:		See table below		External DC: No			
POWER CONSUMPTION:							
Power off mode: ≤5W typ. 3 W (power off mode)				Standby: 0nW (power off mode)			
Maximum: 15 W				Maximum:			
General:							
Q and R according to production division rules : Q ≤ 1% (Major), Q ≤ 4% (Minor)							
Measured according to: R ≤ 3% (CE52)							
DERIVED VERSIONS:							APPROB ATION
	Version	AC Voltage/ Frequency on type plate		Safety			Refer to
	/05	230VAC		+/-10%			Refer to version
	UK	50HZ					
	/12	230VAC		+/-10%			Refer to version chart
	Europe	50HZ					
	/55 latum	120/230VAC		+/-15%			Refer to version chart
		50/60HZ					
	/79	230VAC		+/-15%			Refer to version
	Australian	50HZ					
	/98 Asia Pacific	120/230VAC		+/-15%			
		50/60HZ					
	/77 /78	120/230VAC		+/-15%			
		50/60HZ					
	37	120VAC/ 60HZ		+/-10%			
REMARKS:							
For operation and thermal stability test :							
220/230/240Vac setting : 198Vac to 264Vac							
120Vac setting : 99Vac to 140Vac							
dual voltage ac setting (120Vac / 230Vac) : 99Vac to 140Vac and 196Vac to 264Vac							

TUNER PART

TECHNICAL description:

RF	AM	(circuitry)	FM/AM	(active components)	FM
IF			SI4831	SI4831	
Detector			SI4831	SI4831	
Decoder					

GENERAL part:

WAVE RANGE

FM (12/05/55/79/77/98 /78version)

87-108MHZ

TOLERANCES

TUNING STEP(mm/10kHz)

LOW : +0.3/-0.3MHZ
HIGH: +0.4/-0.4MHZ

0.025

FM (37 version)

87-108MHZ

LOW : +0.3/-0.3MHZ
HIGH: +0.4/-0.4MHZ

0.54

MW

522-1620KHZ

LOW: +30KHZ/-30KHZ
HIGH: +40KHZ/-40KHZ

0.54

AM (37/77/78/55 version)

520-1710KHZ

LOW: +30KHZ/-30KHZ
HIGH: +40KHZ/-40KHZ

AERIAL:

MW Ferrite Bar : 60 mm /D 10mm

FM telescope : 430 mm

FM wire : N/A

Execution - N/A

INDICATORS:

Pointer stroke:

Execution pointer:

Knob indication over:

Field Strength:

ELECTRICAL DATA:

AM:	Nom.	limit	FM:	nom.	limit
RATED OUTPUT POWER 10% THD 80%Mod 120dB	1W	-6DB	AM Suppression	30	25 dB
Amplification reserve	2	+/- 3dB	-3dB limiting point	12	18 dBf
AGC figure of merit	31		Amplification reserve	2	+/-2 dB
Distortion (RF 74 to 94 dBuV/m, m=80%)	5		AFC holding range (average)	300	+/- 150
			7% Distortion	5	7%
			(RF 32 to 72 dBuV, mono Af 100kHz, Stereo : 90%+ 9%)		
			Stereo -46dB quieting	40	44 dBuV
			Cross-talk (RF 1mV, Af 40KHz, 400Hz /1kHz / 5KHz)	21/25/18	18/20/15 dB

TECHNICAL SPECIFICATION

TECHNICAL description:					
	Power supply	Tone Control	AF-Amplifier	Loudspeaker	
Active components			CD8227		
Passive components				2 X 1 W, 8ohm	
GENERAL part:					
Headphone type	None				
Loudspeaker filter, high pass	None				
Loudspeaker filter, low pass	None				
Power stage protection	AC – NO; DC - NO; Temperature – YES; Short circuit – NO				
Public address	No				
INDICATORS:					
Output power or VU-meter	No		: digits:		
Frequency response	No		: digits:		
Low power (battery)	No				
ELECTRICAL DATA:					
TONE/EQUALIZER/DBB					
		Balance control	No		
		Mechanical noise (ISO 1996)			
		Noise overall (ISO)			
		Channel difference at 50mW			
		Hum (vol.max.-20dB to vol.min.)	Limit:	200 nW	
		Residual noise (volume minimum)	Limit:	260 nW	
Input sens.: Nom.		500mV		mV	
for 50mW Limit:				mV	
Line outp.: Nom.				mV	
voltage Limit:				mV	
OUTPUT POWER:					
Mains operation:	D=10%	2 X 1W	Limit: - 1dB		
Battery operation:	D=10%	2 X 1W	Limit: - 1dB		
Music power (MPO) / Peak-MPO (PMPO):	(acc. to DIN45324)				
Short term maximum output power:	-		(acc. to IEC 60268-15)		
Long term maximum output power:	-		(acc. to IEC 60268-15)		
Headphone output voltage/power:					
Bandwidth FTC – 1dB at:	n.a.		(acc. to FTC/16/1/D/432)		
Bandwidth DIN – 3dB at:	-		(acc. to IEC 60268-15)		
Frequency response at Vol. max – 20dB:	typ. 60Hz to 16kHz (±3dB)				
DBB raise level			Disc SBC429 Track 12		
LOUDSPEAKER (output):					
Low pass crossover frequency:	-	kHz	tolerance:	Hz	
High pass crossover frequency:	-	kHz	tolerance:	Hz	
Short term maximum output power:	- W (acc. to IEC 60268-15)				
Long term maximum output power:	- W (acc. to IEC 60268-15)				
Frequency response at:	-	Hz	kHz		
REMARKS:					
27 : Measured in Tuner mode; 28: CD or LINE IN mode.					

TECHNICAL SPECIFICATION

Technical description:					
	Input	Output	Motor/control	Logic control	1
Active components				TC94A77FG-203	2
Passive components					3
	Signal processing	D/A converter	HF-preamplifier	Servoprocessor	4
Active components	CD:	CD:	D9258PH		
	TC94A77FG-203	TC94A77FG-203			
					5
Passive components					6
Indicators/Display/Keys:					
Display: LCD for Track No. display 3 Digit					7
Keys: Slide switches & tact switches					8
Playability: (acc. to AHR-82-Gbu-00-4201)					
	Limit	Typical	Testdisc		9
Wedge	600 µm	900 µm	TNO 7,9 of SBC 444A (7104 099 24990)		10
Eccentric	150 µm	200 µm	TNO 1,24 of 200µm disc (7104 099 24960)		11
Fingerprint	No audible defect		TNO 11 of Subchassis 8A		12
Black dot	500 µm	600 µm	TNO 13, 14 of SBC 444A (7104 099 24990)		13
Double black dot	No failure		TNO 9 of Subchassis 8A		14
Skew 0.6 deg, 8cm	No audible defect		TNO 1,6 of 0.6deg C, 8cm skew disc		15
Bad HF track	No audible defect		TNO 8 of Subchassis 8A		16
Heavy fingerprint	No track jumps/plops		TNO 10 of Subchassis 8A		17
Maximum diameter	No audio effect		Last TNO of Subchassis 8A		18
Thick disc	No failure		Thick test disc		19
Thin disc	No failure		Thin test disc		20
Vertical deviation disc	No failure		TNO 1,16 of ABEX TCD-732RA		21
			(VDD +/- 0.5mm)		
Playback position	Horizontal, Normal position (Set is located on a flat surface, floor)				22
- Playback of above mentioned tracks possible without track loss or audible defects.					23
- This unit can playback CD-R or CD-RW discs.					
Shock resistance: (acc. to AR 13-A6-CD-068)					
± Z axis	5 G				24
± X or Y axis	5 G				25

TECHNICAL SPECIFICATION

Acoustical noise:			
Mode: Play/Pause	35 dBA max. (45 dbA in Search mode)		26
Mode: Jump (Next)	45 dBA max.		27
Acoustic feedback:	Acoustical feedback is not allowed.	Test disc TNO 2,6,11,18,19,20 of SBC444 , 10% THD o/p , DBB on	
AUDIO part: (Measured with Audio Signals Disc-1, 7104 078 04911 on Speakers or Headphone socket with nom. load)			
	Typ.	Limit	
Output level (TNO1)	2.85V		28
SNR unwt'd.	60 dB	50 dB	29
SNR wtd. dBA	62 dBA	57 dBA	30
Crosstalk (1kHz)	35 dB	30 dB	31
TNO 67, 71			
Crosstalk (other range)	35 dB	30 dB	32
TNO 66 – 73 (16 TO 16kHz)			
Frequency response	-1.5dB	±3dB at 80Hz	33
Vol.max.–20 dB (DBB on)	-1dB	±3dB at 12.5kHz	
Frequency response at DBB off (+/- 3dB)	80Hz	100 Hz	34
	12.5k	10 kHz	
THD (1kHz, 0 dB)	1%	1.50%	35
THD (overall frequency response range, 0dB)	2%	3%	36
Channel difference	0.5 dB	2 dB	Residual Noise Volme Min 1.8MV
Frequency accuracy	-	+/-0.5 %	Hum Volme Min 1.8MV
De-emphasis	75µs / 50µs Switchable via Subcode information		39
REMARKS:			
- Amplification reserve for CD = +2dB (±2dB); Ref. Level for CD is a 1kHz, -6dB (Audio signal disc 1, track 35)			40

TECHNICAL SPECIFICATION

CD-RW /MP3 Test discs :					
	(A)	Audio signal disc 1	(N)	MP3CD-1.0B Multi-Purpose	
	(B)	SBC444A	(O)	MP3CD-MS-1.0B Multi-Session	
	(G)	Burn-in SBC 442	(P)	MP3CD-MX-1.0B Mixed Mode CD	
	(K)	Printed CD-RW	(Q)	MP3CD-XA-1.0B CD Extra	
	(L)	Low reflect CD-RW	(R)	MP3CD1.0D	
	(M)	High reflected CD-RW	(S)	MP3CD-M400-1.0A	
			(T)	MP3CD-Multiformat-1.0B	
	Description	condition (test disc)		Noraml	limit
CD-RW playability					
1	Fingerprint	“K” TNO 18		No audible disturbance	
2	Black dot	“K” 13, 17	um	800	400
3	Low reflection	“L”		No audible disturbance	
4	High reflection	“M”		Startup	
MP3 playability : See specification on CD-DA					
MP3 - Data-format-check					
Remark :support ISO-9660, Joliet format and UDF 1.0 & 2.0					
1	File format check	Hml file of “N”		File in non supported formats are skipped.	
2	Sample rate check	“N”		No audible disturbance	
3	Bitrate check 32,40, 48, 56, 64, 80, 96, 112, 128, 160, 192, 224, 250, 320 kbps, VBR (variable bit rate)	“N”		No audible disturbance	
4	Multisession	“O”		All titles accessible, no audible disturbance	
5	Iso9660	“N”		All titles accessible, no audible disturbance	
6	Playlist m3u			Not supported	
7	Id3 check	“N”		Not supported	
8	CD-Extra (1 audio seesion + 1 digitalsession)	“Q” Remark : selectable by mode button		No audible disturbance.	
9	Direct CD	“R”		No audible disturbance	
10	Mixed CD	“P”		No audible disturbance	
11	AAC-playback			Not supported	
12	WMA-playback			supported	
13	Max. titles / directories	“S” max. 350 titles and directories, avg. length of filename/foldername is 20 characters		All titles accessible, no audible disturbance.	

VERSION VARIATION

Type /Versions:		AZ300(X)								
Board in used:	Service policy	/55	/78							
Main BOARD		M+C	M+C							
KEY BOARD		M+C	M+C							
Type /Versions:		AZ300(X)								
Features	Feature diffrence	/55	/78							
RDS										
VOLTAGE SELECTOR										
ECO STANDBY - DARK		√	√							
<p>* TIPS : C -- Component Lever Repair. M -- Module Lever Repair √ -- Used</p>										

2.0 SAFETY INSTRUCTIONS

(GB) WARNING

All ICs and many other semi-conductors are susceptible to electrostatic discharges (ESD). Careless handling during repair can reduce life drastically. When repairing, make sure that you are connected with the same potential as the mass of the set via a wrist wrap with resistance. Keep components and tools also at this potential.

ESD**(NL)** WAARSCHUWING

Alle IC's en vele andere halfgeleiders zijn gevoelig voor electrostatische ontladingen (ESD). Onzorgvuldig behandelen tijdens reparatie kan de levensduur drastisch doen verminderen. Zorg ervoor dat u tijdens reparatie via een polsband met weerstand verbonden bent met hetzelfde potentiaal als de massa van het apparaat. Houd componenten en hulpmiddelen ook op ditzelfde potentiaal.

(F) ATTENTION

Tous les IC et beaucoup d'autres semi-conducteurs sont sensibles aux décharges statiques (ESD). Leur longévité pourrait être considérablement écourtée par le fait qu'aucune précaution n'est prise à leur manipulation. Lors de réparations, s'assurer de bien être relié au même potentiel que la masse de l'appareil et enfilez le bracelet serti d'une résistance de sécurité. Veiller à ce que les composants ainsi que les outils que l'on utilise soient également à ce potentiel.

(D) WARNUNG

Alle ICs und viele andere Halbleiter sind empfindlich gegenüber elektrostatischen Entladungen (ESD). Unsorgfältige Behandlung im Reparaturfall kann die Lebensdauer drastisch reduzieren. Veranlassen Sie, dass Sie im Reparaturfall über ein Pulsarmband mit Widerstand verbunden sind mit dem gleichen Potential wie die Masse des Gerätes. Bauteile und Hilfsmittel auch auf dieses gleiche Potential halten.

(I) AVVERTIMENTO

Tutti IC e parecchi semi-conduttori sono sensibili alle scariche statiche (ESD). La loro longevità potrebbe essere fortemente ridotta in caso di non osservazione della più grande cauzione alla loro manipolazione. Durante le riparazioni occorre quindi essere collegato allo stesso potenziale che quello della massa dell'apparecchio tramite un braccialetto a resistenza. Assicurarsi che i componenti e anche gli utensili con quali si lavora siano anche a questo potenziale.

(GB)

Safety regulations require that the set be restored to its original condition and that parts which are identical with those specified, be used.

"Pour votre sécurité, ces documents doivent être utilisés par des spécialistes agréés, seuls habilités à réparer votre appareil en panne".

(NL)

Veiligheidsbepalingen vereisen, dat het apparaat bij reparatie in zijn oorspronkelijke toestand wordt teruggebracht en dat onderdelen, identiek aan de gespecificeerde, worden toegepast.

**(F)**

Les normes de sécurité exigent que l'appareil soit remis à l'état d'origine et que soient utilisés les pièces de rechange identiques à celles spécifiées.

(GB) Warning !

Invisible laser radiation when open. Avoid direct exposure to beam.

(D)

Bei jeder Reparatur sind die geltenden Sicherheitsvorschriften zu beachten. Der Originalzustand des Geräts darf nicht verändert werden; für Reparaturen sind Original-Ersatzteile zu verwenden.

(S) Varning !

Osynlig laserstrålning när apparaten är öppnad och spårren är urkopplad. Beträkta ej strålen.

(I)

Le norme di sicurezza esigono che l'apparecchio venga rimesso nelle condizioni originali e che siano utilizzati i pezzi di ricambio identici a quelli specificati.

(SF) Varoitus !

Avatussa laitteessa ja suojalukituksen ohitettaessa olet alltiina näkymättömälle laserisäteilylle. Älä katso säteeseen!

"After servicing and before returning set to customer perform a leakage current measurement test from all exposed metal parts to earth ground to assure no shock hazard exist. The leakage current must not exceed 0.5mA."

DK Advarsel !

Usynlig laserstrålning ved åbning når sikkerhedsafbrydere er ude af funktion. Undgå udsættelse for strålning.

Caution: These servicing instructions are for use by qualified service personnel only.

To reduce the risk of electric shock do not perform any servicing other than that contained in the operating instructions unless you are qualified to do so.

SET BLOCK DIAGRAM

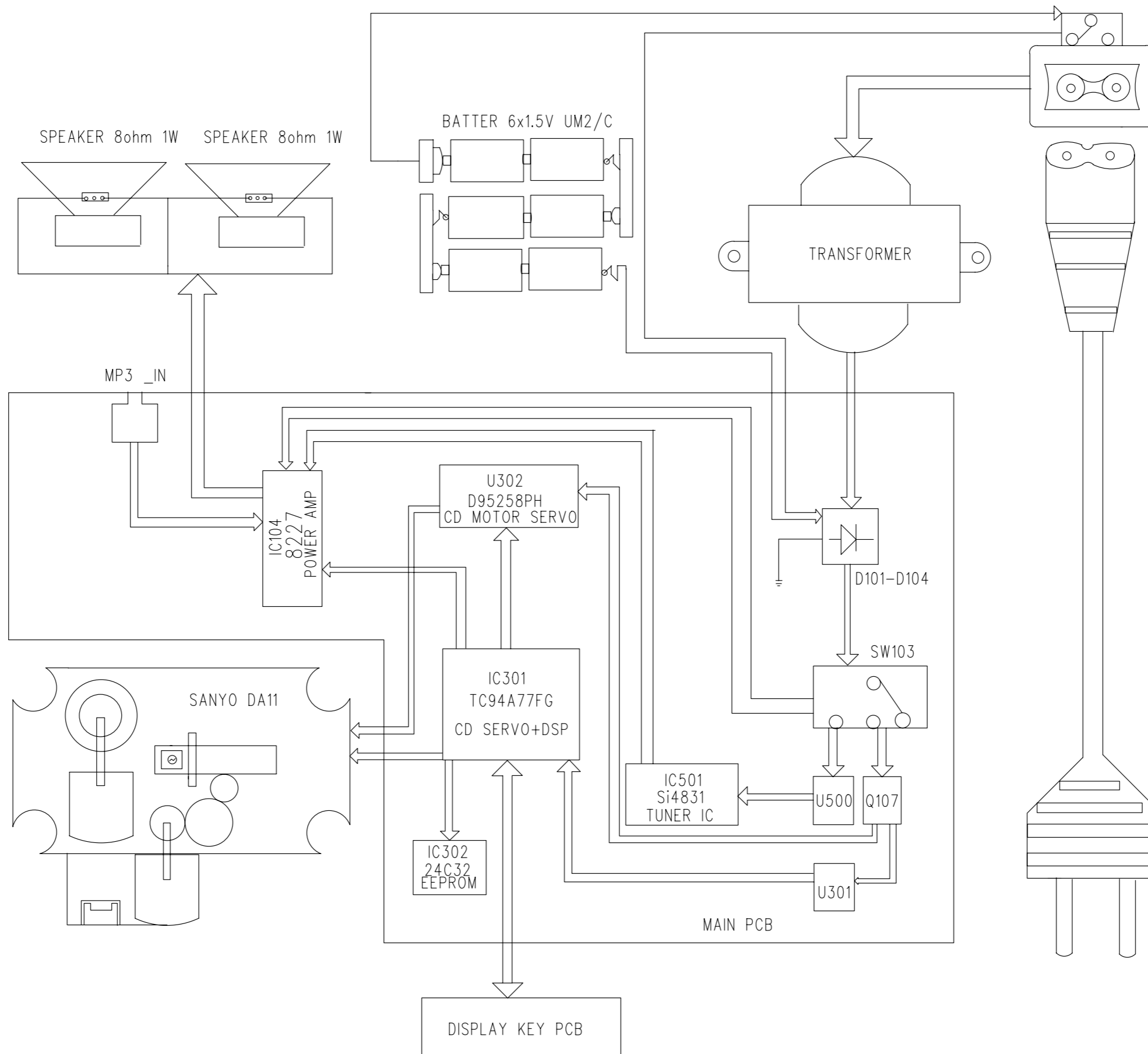

WIRE CONNECT DIAGRAM

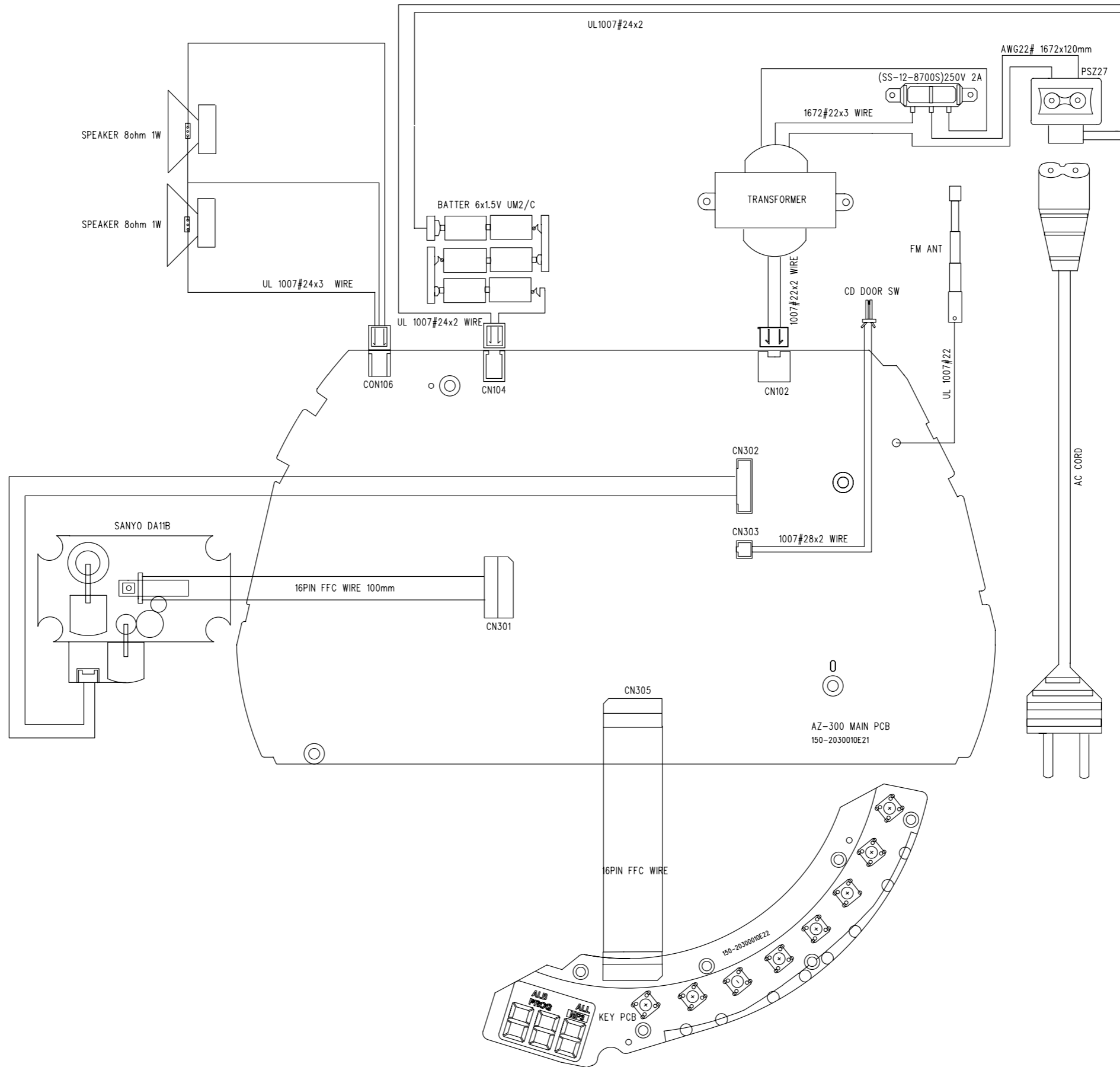

CIRCUIT DIAGRAM -MAIN + KEY BOARD PART1

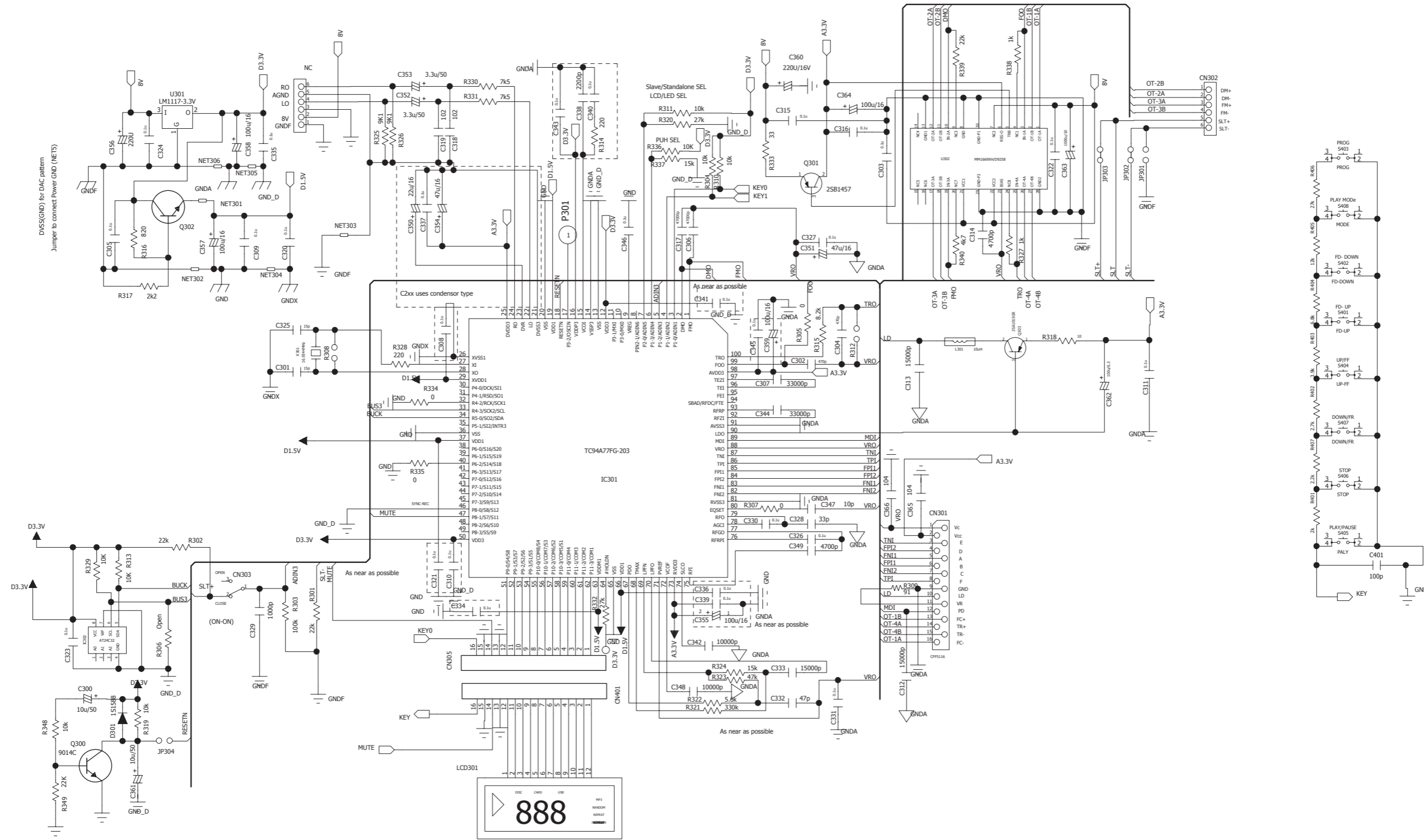

Mode:	Pin 7	Volt
Slave		0V
LED 16k EEPROM		1.35V
LED 33k EEPROM		1.9V
LCD 33k EEPROM		2.45V
LCD 16k EEPROM		3.3V

PUH SEL	Pin 6	Volt	R8	R17
Sony KSS-213CL		0V	Open	15k
Richly RB01		1.2V	27k	15k
Sanyo DA11VF		2V	10k	15k
Sony KSS-900AAA		3.3V	10k	Open

	Pin 32
USB Enable	Pull Up
USB Disable	Pull Down

	Pin 40
SD Enable	Pull Up
SD Disable	Pull Down

1. R16 change to 91
2. Pin 8 add USB power control
3. Pin 7 LCD/LED/Slave/Standalone SEL
4. Add R10: 4.7k ohm
5. R123 change to 8.2k ohm
6. Change R18 to open, R19 to 10k
7. Add R20 10k ohm
8. Add R49 2.2k ohm

CIRCUIT DIAGRAM -MAIN BOARD PART 2

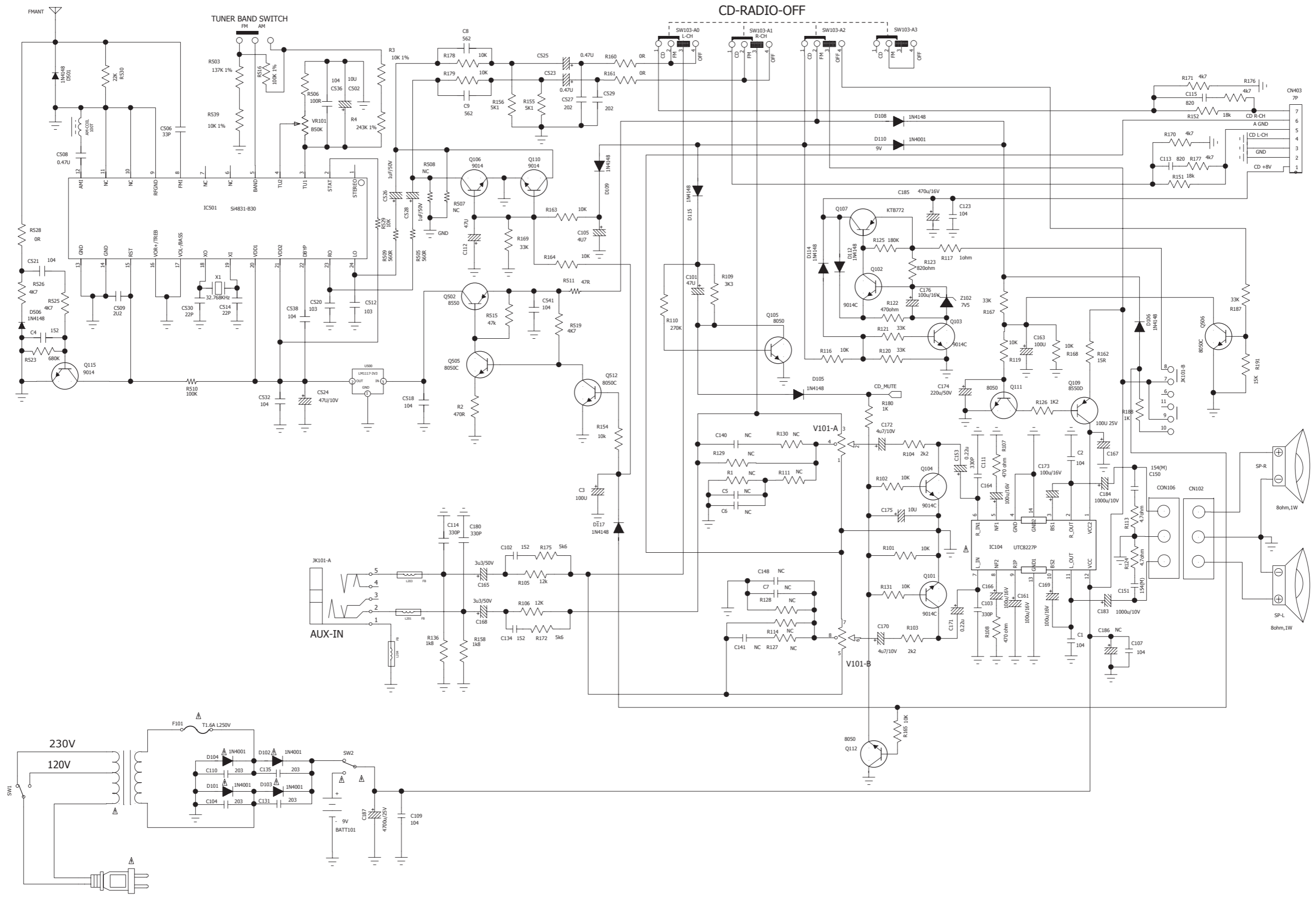

LAYOUT DIAGARM -MAIN BOARD
TOP SIDE VIEW

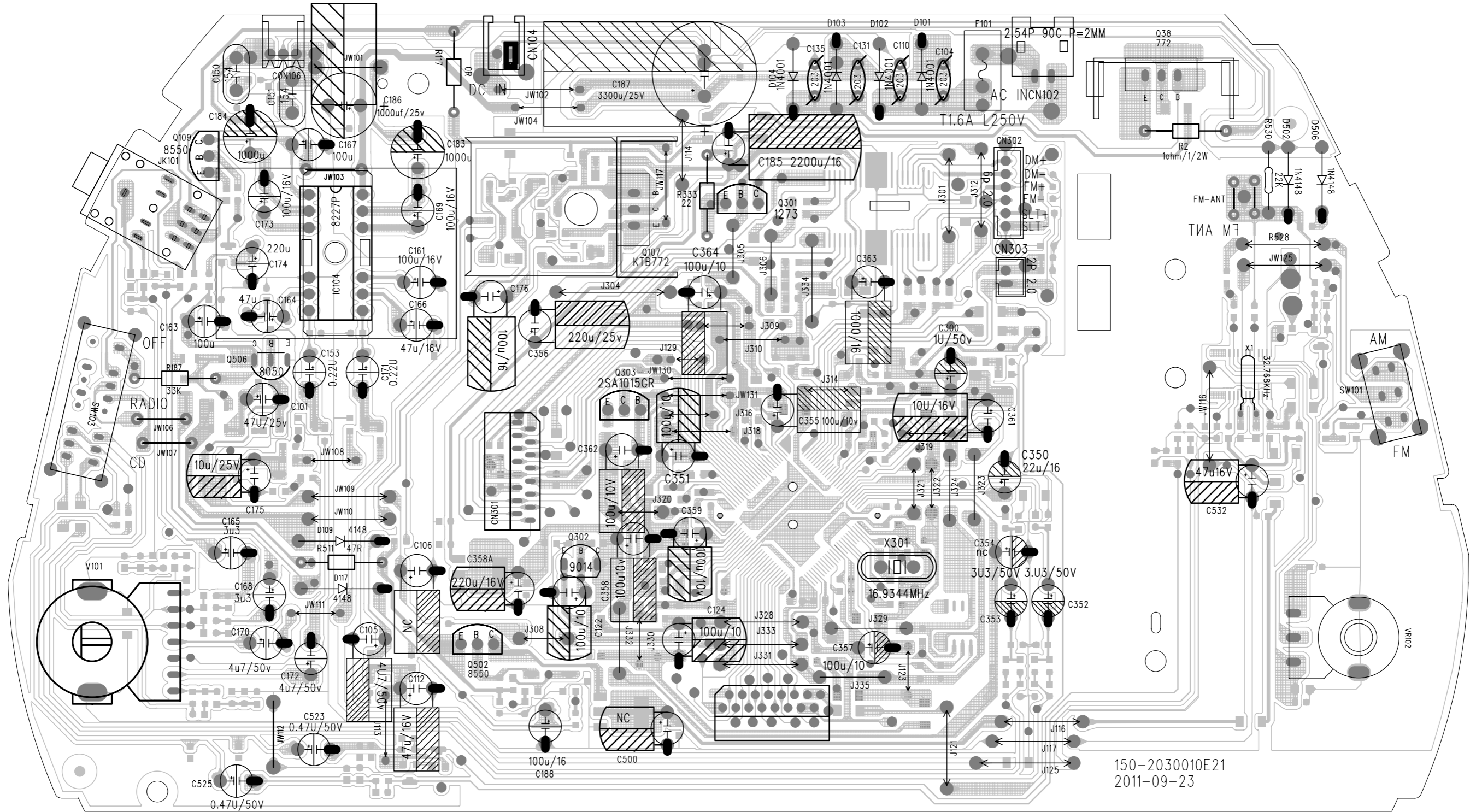

150-2030010E21
2011-09-23

LAYOUT DIAGRAM - MAIN BOARD
BOTTOM SIDE VIEW

5-2

5-2

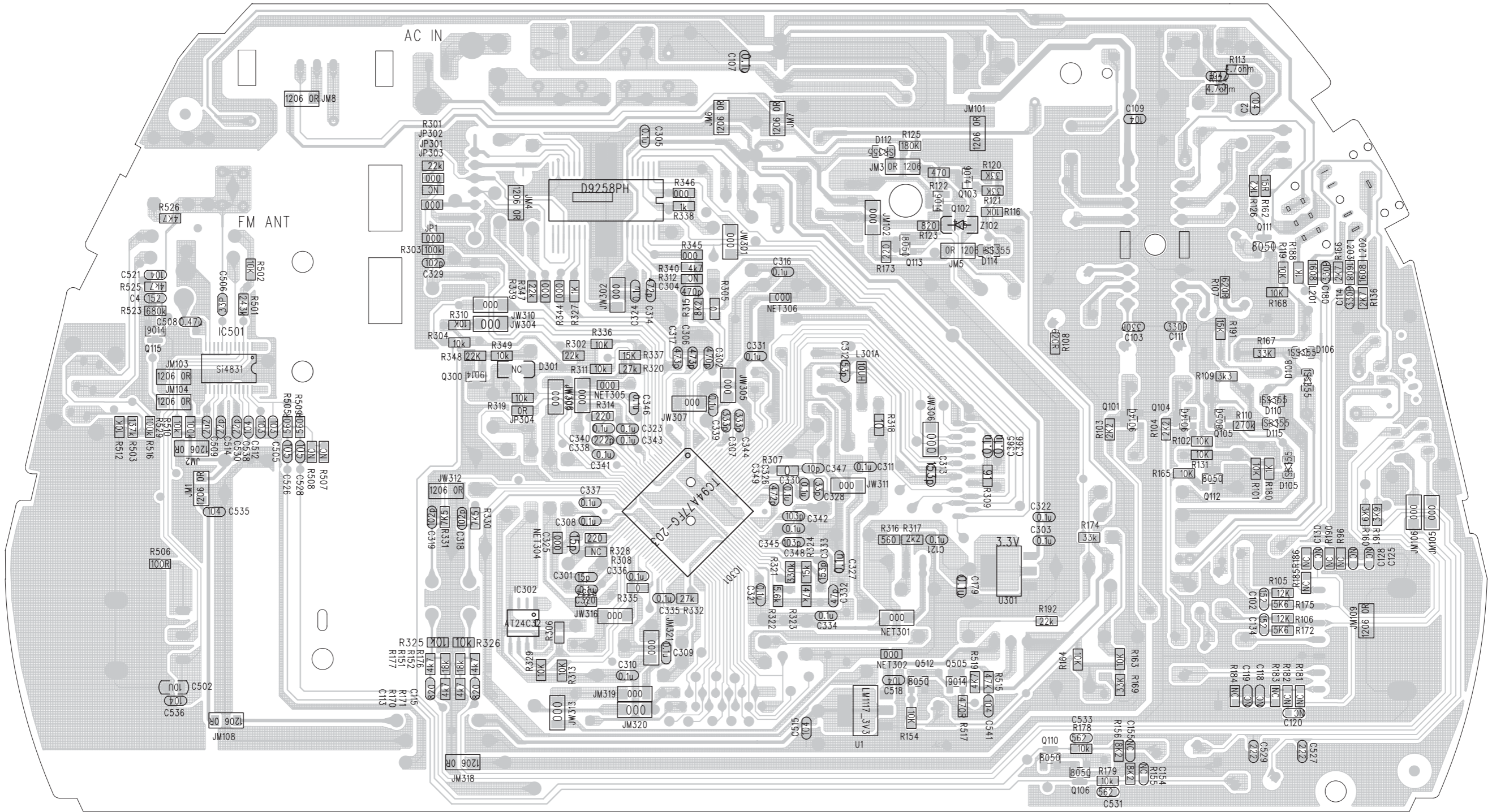

LAYOUT DIAGARM -KEY BOARD
TOP VIEW

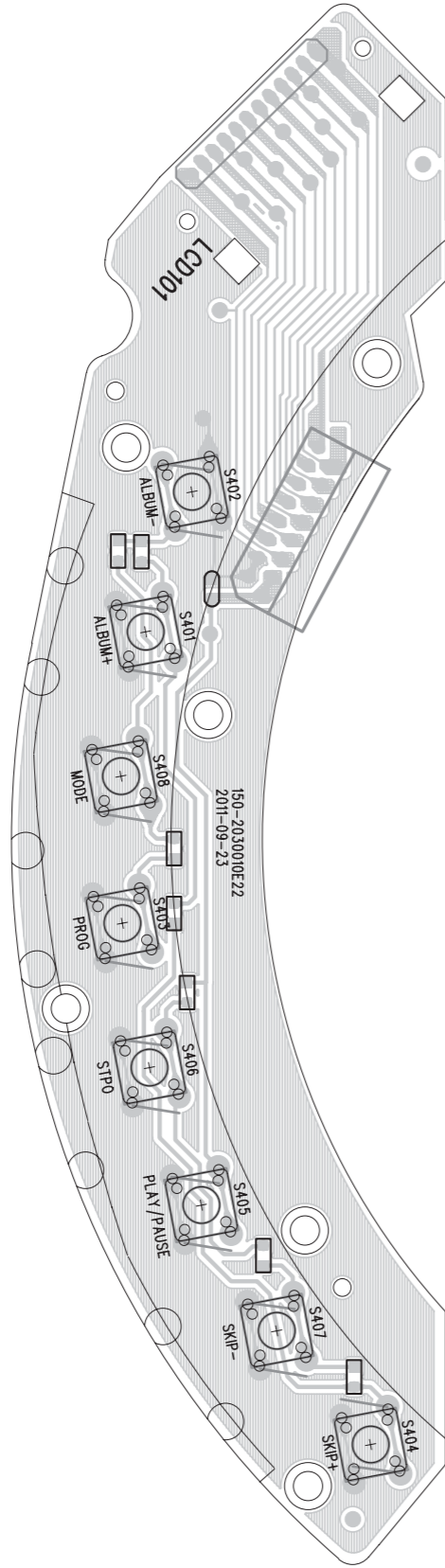

LAYOUT DIAGARM -KEY BOARD
BOTTOM VIEW

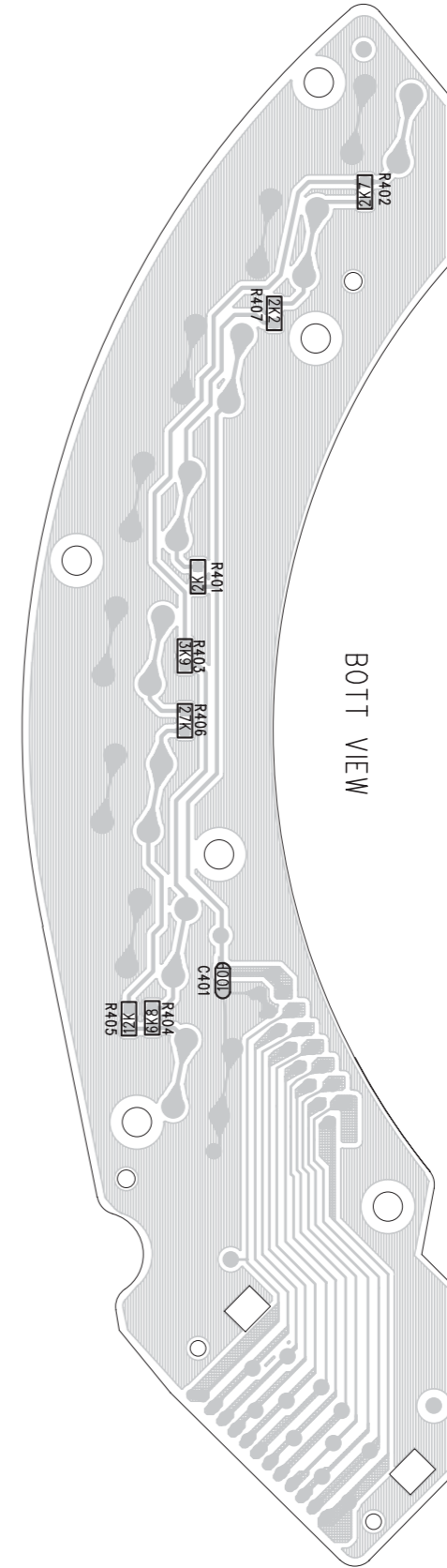

EXPLODED VIEW DIAGRAM

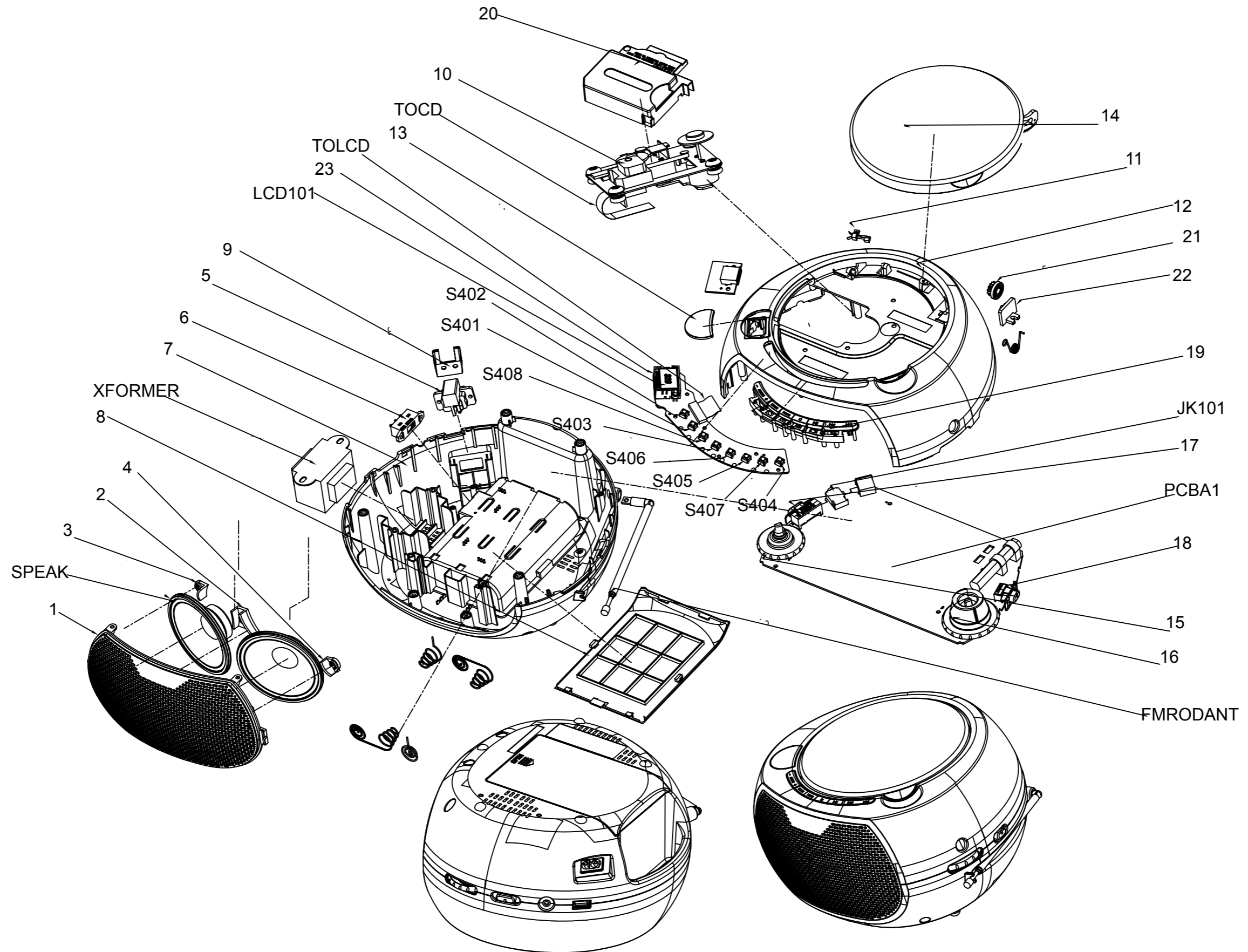

Version History

V1.0: initial release

V1.1: Add /78 version

V1.2: Add AZ300X/78 version